

ARTIST

VERRIERE LIGHT PARTITION



CONCEPT



"Créativité
au service de
vos clients"

*"Let creativity
meet your needs"*

LE CONCEPT ARTIST

La gamme ARTIST est parfaitement adaptée à la conception et à la réalisation de verrières d'intérieur sur mesure. La finesse des profils en aluminium laqué renforce l'aspect cloison atelier recherché. Le nombre de configurations possibles permet une grande liberté de création et l'adaptation à de nombreux espaces intérieurs, cuisine, salon, hall, bureaux...

ARTIST CONCEPT

The range is perfectly adapted for interior tailor made light partitioning. The powder-coated thin aluminium profiles increase the factory/plant aspect.

Many patterns are possible. They will all let you create and adapt to many interior places, such as kitchens, living rooms, lobbies, offices...



1

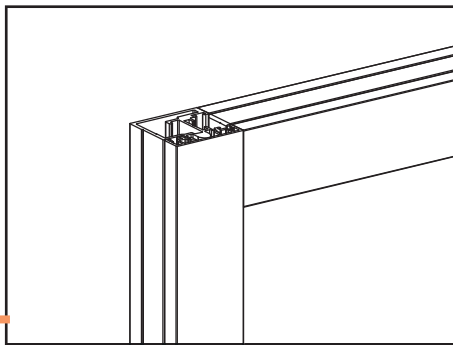

Assemblage cadre
Frame assembly

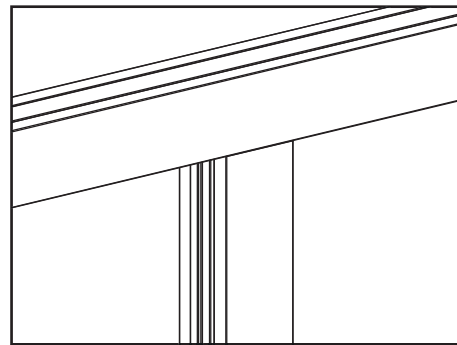

Assemblage cadre et traverse verticale
Post and vertical transom assembly



2

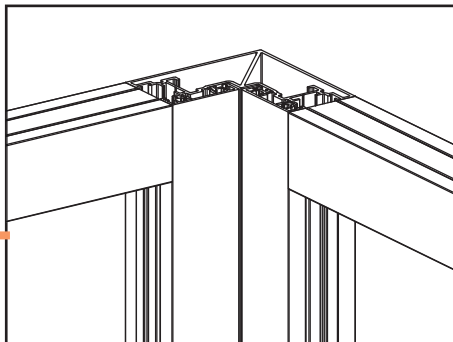

Assemblage cadre et poteau 2 départs
Frame and 2D post assembly

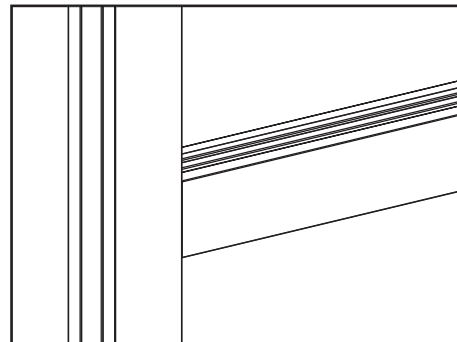

Assemblage traverse verticale et traverse horizontale
Vertical and horizontal transom assembly



3

Assemblages

Tous les assemblages se font en coupes droites avec equerre.

Assemblies

All assemblies are done with straight cut, corner cleat.



4

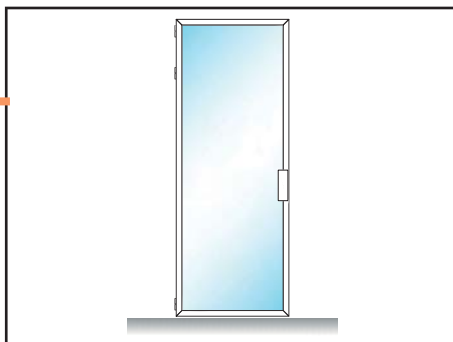

Porte vitrée
Glazed door

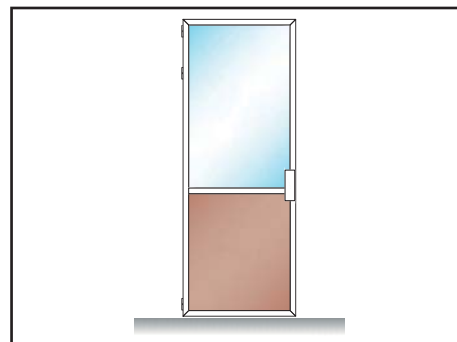

Porte semi-vitrée
Half-glazed door



5

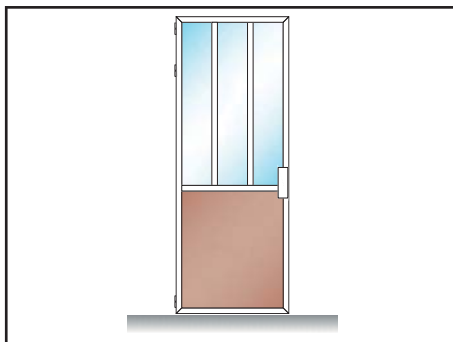

Porte semi-vitrée avec traverses verticales
Half-glazed door with vertical transoms

Ouvrants

- Trois configurations pour les ouvrants

Opening frames

- Three possibilities

STRUCTURE

- 1 - Cadre
- 2 - Traverse
- 3 - Poteau 2D
- 4 - Parcloses
- 5 - Huisserie

STRUCTURE

- 1 - Frame
- 2 - Transom
- 3 - 2D post
- 4 - Glazing bead
- 5 - Door frame



PRODUIT

Une grande variété de configurations possibles pour structurer tous les espaces.

PRODUCT

A wide range of possibilities to divide your spaces.

1

- 1 - Univers cuisine.
Kitchen design.
- 2 - Univers nuit.
Night design.
- 3 - Univers jour.
Day design.
- 4 - Univers tertiaire.
Interior fit out design.

MATIÈRE/FINITION

	Matières	Finitions
Profils	Aluminium	Laqué Noir sablé

MATERIAL/FINISH

	Material	Finish
Profiles	Aluminium	Powdercoated Black Sand



2



3



4

Structure / Structure

Cadre verrière

Frame

Longueur / Length: 5300 / 2550 mm

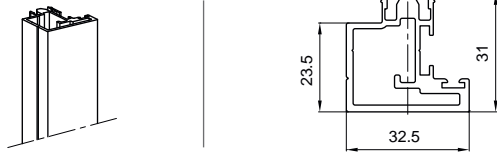

• Réf / Art. no. 50MT01-U / 50MT01-Z

Parclose verrière

Glazing bead

Longueur / Length: 5300 / 2550 mm



• Réf / Art. no. 50PR01-U / 50PR01-Z

Traverse verrière

Transom

Longueur / Length: 5300 / 2550 mm

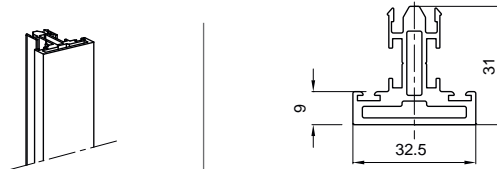

• Réf / Art. no. 50TR01-U / 50TR01-Z

Poteau 2D verrière

2 D Post

Longueur / Length: 6030 / 3000 mm

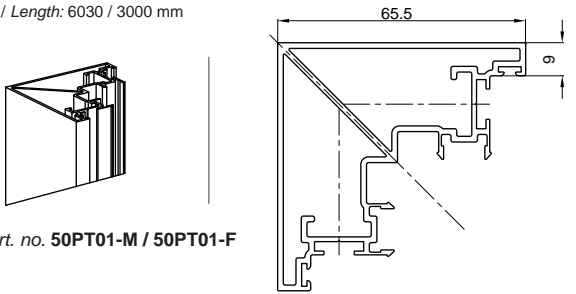

• Réf / Art. no. 50PT01-M / 50PT01-F

Huisserie verrière

Doorframe

Longueur / Length: 5400 mm

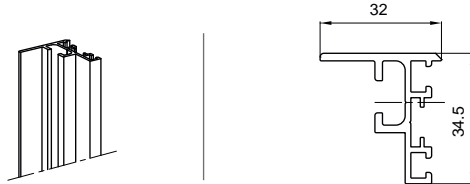

• Réf / Art. no. 50HC01-L

Kit equerres cage 2.5x13

Corner cleat 2.5x13

Quantité / Quantity: x4

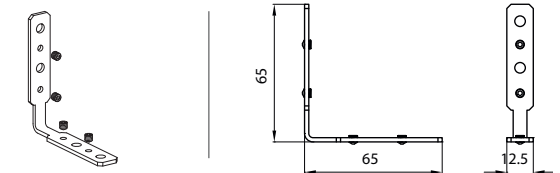

• Réf / Art. no. 90KA02

Joint PVC pour parclose alu

PVC Gasket for aluminium glazing bead

Longueur / Length: 6030 mm



• Réf / Art. no. 606000-M

Porte / Door

Montant porte Artist

Door post

Longueur / Length: 6400 mm

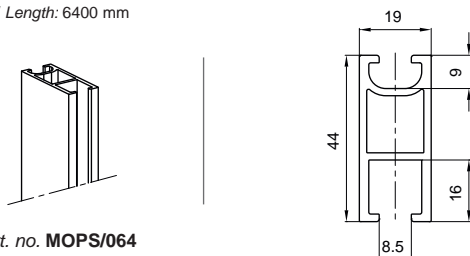

• Réf / Art. no. MOPS/064

Equerre à viser 15x15 mm

Corner cleat 15x15mm

Longueur / Length: 6000 mm

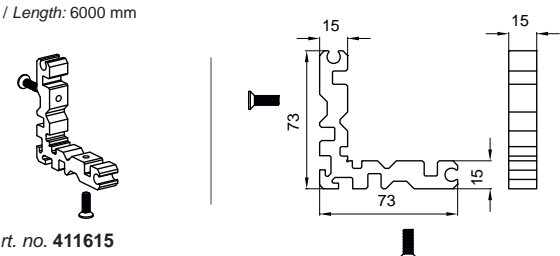

• Réf / Art. no. 411615

Porte / Door

Traverse porte Artist Door transom

Longueur / Length: 6100 mm

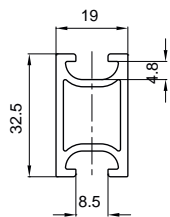
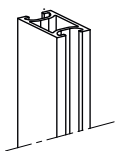

• Réf / Art. no. 202032

Bloc d'assemblage pour cage de 15 x 15 mm à 90° Junction block for 15x15mm chamber, 90°

Quantité / Quantity: x1

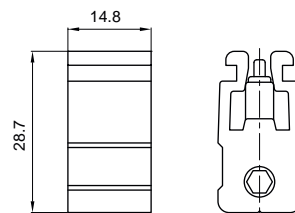
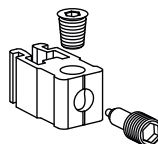

• Réf / Art. no. 401715

Kit paumelle à clamer Cramp iron hinges kit

Quantité / Quantity: x1

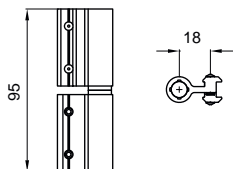
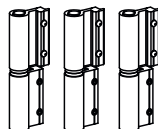

• Réf / Art. no. 90KA01

Serrure à rouleau sans cylindre Roller lock without cylinder

Quantité / Quantity: x1

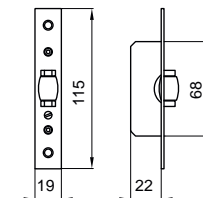

• Réf / Art. no. 50SR01

Cale bois de vitrage 3 mm 3mm glass wooden spacer

Quantité / Quantity: x1

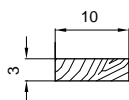
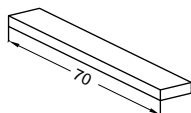

• Réf / Art. no. 624/000

Joint a bourrer 2 mm 2mm snap-in gasket

Quantité / Quantity: vente au détail par mètre linéaire / retail sale by linear meter

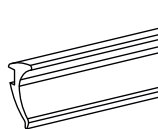

• Réf / Art. no. 120008DT

Kit poignée de tirage "aileron" "Fin" pull handle kit

Quantité / Quantity: x1

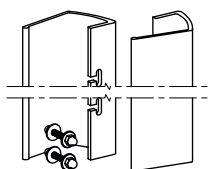

• Réf / Art. no. 50KA01

Poignée de tirage "aileron" "Fin" pull handle

Quantité / Quantity: x1

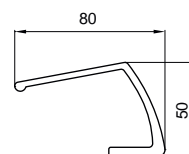
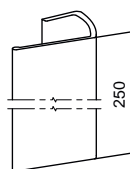

• Réf / Art. no. 50AC01

Kit fixation poignée "aileron" "Fin" handle fitting kit

Quantité / Quantity: x1

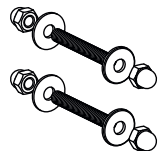

• Réf / Art. no. 50AC02

Cache rainure PVC PVC Finishing rod

Quantité / Quantity: vente au détail par mètre linéaire / retail sale by linear meter

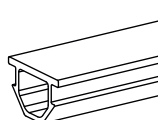

• Réf / Art. no. 301115DT

Outils / Tools

Clé clippage verrière Light partition clipping key

Quantité / Quantity: x1

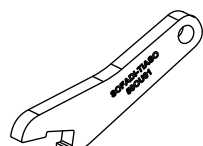

• Réf / Art. no. 50OU01



Fenêtres SCHMITT

18, Rue des Prés

57450 THEDING

Tél: 03.87.00.24.10 - Fax: 03.87.89.13.21

www.fenetres-schmitt.fr